

ÉVACUATION DES CONDENSATS

P. 57 > 66



Tuyaux d'évacuation condensats

LIBELLÉS	DIMENSIONS	CLIMA CONCEPT CODE CBM
Tuyau d'évacuation condensats D16/18		50 m) CLI04506
Tuyau d'évacuation condensats intérieur lisse D16	ø int. : 16 mm	30 m) CLI04502
Tuyau d'évacuation condensats intérieur lisse D18	ø int. : 18 mm	30 m) CLI04503
Tuyau d'évacuation condensats intérieur lisse D20	ø int. : 20 mm	30 m) CLI04504



Tuyaux d'évacuation isolé condensats

LIBELLÉS	DIMENSIONS	INABA DENKO™ CODE CBM
Tuyau d'évacuation condensats isolé D14	ø ext. : 21 mm - ø int. : 14 mm	20 m) CLI04507



Tubes cristal

LIBELLÉS	DIMENSIONS	CLIMA CONCEPT CODE CBM
Tube cristal 3x5	ø ext. : 5 mm - ø int. : 3 mm	50 m) CLI04511
Tube cristal 6x8	ø ext. : 8 mm - ø int. : 6 mm	50 m) CLI04519
Tube cristal 6x9	ø ext. : 9 mm - ø int. : 6 mm	50 m) CLI04510
Tube cristal 7x10	ø ext. : 10 mm - ø int. : 7 mm	50 m) CLI04513
Tube cristal 9x12	ø ext. : 12 mm - ø int. : 9 mm	50 m) CLI04514
Tube cristal 10x14	ø ext. : 14 mm - ø int. : 10 mm	50 m) CLI04517



Tubes renforcés

LIBELLÉS	DIMENSIONS	CODE CBM
Tube clair renforcé 10x15	ø ext. : 15 mm - ø int. : 10 mm	50 m) CLI04515
Tube clair renforcé 16x22	ø ext. : 22 mm - ø int. : 16 mm	50 m) CLI04516

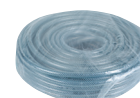

ÉVACUATION DES CONDENSATS

Tubes silicone

LIBELLÉS

DIMENSIONS

CLIMA  CONCEPT

CODE CBM

LIBELLÉS	DIMENSIONS		CODE CBM
Tube silicone 9x6	ø ext. : 9 mm - ø int. : 6 mm		CLI04571
Tube silicone 21x15	ø ext. : 21 mm - ø int. : 15 mm		CLI04509



Tubes de condensation rigides

Emboîtement avec système de joint à étanchéité.

LIBELLÉS

CLIMA  CONCEPT

CODE CBM

Tube de condensats rigide L 2 m - D.20 mm	CLI04520
Coude 45° D.20 mm	CLI04522
Coude 90° D.20 mm	CLI04524
Connecteur T D.20 mm	CLI04526
Extension D.20 mm	CLI04528
Clip de fixation	CLI04532
Tube condensat rigide L. 2m - D. 25 mm	CLI04533
Clip de fixation D. 25 mm	CLI04534
Extension D. 25 mm	CLI04536
Coude 135° D. 25 mm	CLI04538
Coude 90° D. 25 mm	CLI04541
Connecteur T D. 25 mm	CLI04545
Tube condensat rigide L. 2m - D. 32 mm	CLI04546
Clip de fixation D. 32 mm	CLI04547
Extension D. 32 mm	CLI04549
Coude 135° D. 32 mm	CLI04551
Coude 90° D. 32 mm	CLI04553
Connecteur T D. 32 mm	CLI04555

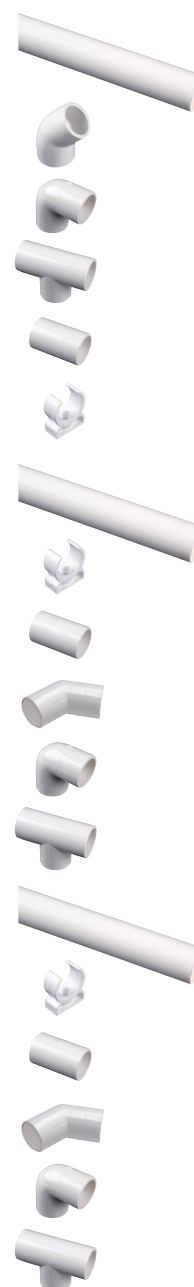

Tubes de condensation accessoires rigides

LIBELLÉS

CLIMA CONCEPT

CODE CBM

Raccord réduction 20 mm	A = Ø20 B = Ø16 - 18 - 20		CLI04529	
Raccord réduction 25 mm	A = Ø25 B = Ø16 - 18 - 20		CLI04530	
Raccord réduction 30 mm	A = Ø30 B = Ø16 - 18 - 20		CLI04531	
Coupe tube PVC			CLI02226	

Accessoires pompes condensats

LIBELLÉS

CLIMA CONCEPT

CODE CBM

Raccord rallonge 6 mm			CLI04580	
T de dérivation 6 mm			CLI04581	
Angle diamètre 6 mm			CLI04582	
Y de dérivation 6 mm			CLI04583	
Clapet anti retour			CLI04584	

Raccords tuyaux de condensats

LIBELLÉS

CLIMA CONCEPT

CODE CBM

LIBELLÉS	DESCRIPTION		CODE CBM	
Raccord réduction 16 mm	Entrée 16 mm - Sortie 14/16/18/20 mm		CLI04560	
Raccord réduction 18 mm	Entrée 18 mm - Sortie 14/16/18/20 mm		CLI04561	
Raccord réduction 20 mm	Entrée 20 mm - Sortie 14/16/18/20 mm		CLI04562	
Raccord réduction 25 mm	Entrée 25 mm - Sortie 14/16/18/20 mm		CLI04563	
Raccord réduction 32 mm	Entrée 32 mm - Sortie 14/16/18/20 mm		CLI04564	
Connecteur Y 16 x 14 mm			CLI04512	
Rallonge	D. 16/18/20 mm		CLI04540	
Siphon	D. 16/18/20 mm		CLI04542	
T de dérivation	D. 16/18/20 mm		CLI04544	

ÉVACUATION DES CONDENSATS

DHJ raccord tuyau condensat

LIBELLÉS	D. EXT	LONG.	PCS/PKG	INABA DENKO™ CODE CBM
DHJ-16 pour tuyaux 16-18	ø16/18	28		CLI04615

Dimensions
28

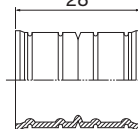

Unité : mm



LIBELLÉS	D. EXT	PCS/PKG	INABA DENKO™ CODE CBM
DY-1416 pour tuyaux 16-18	ø16/18		CLI04616

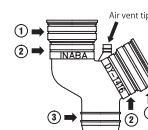

① En forme de soufflet de DH-16/DHQ-16
② En forme de soufflet de DH-14/DHQ-14
③ En forme de soufflet de DH-14/16 et DHQ-14/16

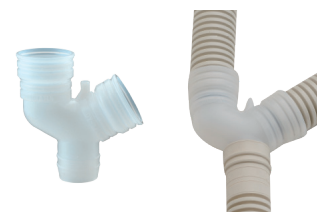

NDA adaptateur

LIBELLÉS	DIAMETRE	PCS/PKG	INABA DENKO™ CODE CBM
NDA-1416 pour tuyaux 16-18	ø26/32		CLI04618



DS accroche tuyau condensat

LIBELLÉS	A	B	C	D	E	PCS/PKG	INABA DENKO™ CODE CBM
DS-16 pour tuyaux 16-18	28,6	20	41,3	25,3	21		CLI04620

Dimensions

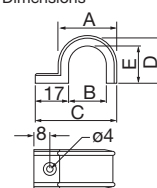

Unité : mm



DHB clapet anti retour/odeur

LIBELLÉS	DIAMETRE	INABA DENKO™ CODE CBM
DHB-1416	ø16/18	CLI04621

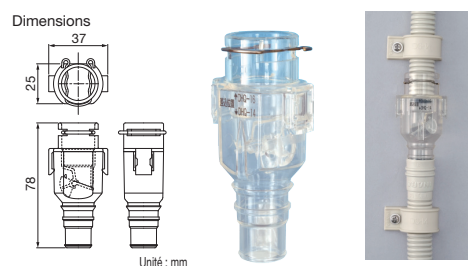

DC capuchon tuyau condensat

LIBELLÉS	DIAMETRE	PCS/PKG	INABA DENKO™ CODE CBM
DC-1416	ø16		CLI04622

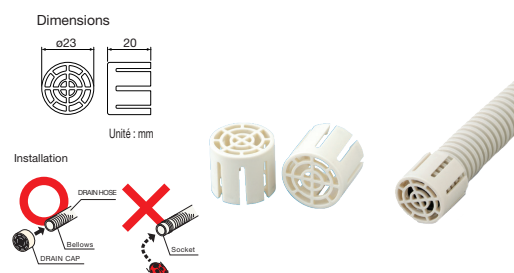

DL canal de drainage

LIBELLÉS	LONG.	LARG.	HAUTEUR	PCS/PKG	INABA DENKO™ CODE CBM
DL-25	25 m	55 mm	5,5 mm		CLI04623

Sans fixation, à poser au sol



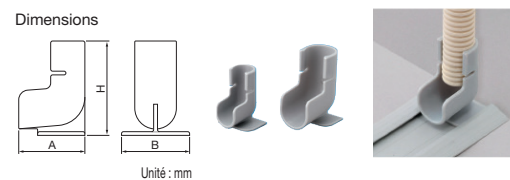

DL-H adaptateur canal drainage

LIBELLÉS	A	B	H	PCS/PKG	INABA DENKO™ CODE CBM
DL-H13	35	36	50		CLI04624
DL-H20	50	65		CLI04625	



ÉVACUATION DES CONDENSATS

DSH-14V adaptateur D14

LIBELLÉS	A	B	ØC	ØD	PCS/ PKG	INABA DENKO™ CODE CBM
DSH-14-13V	50	38	18,4	ø24		CLIO4626
DSH-14-16V	54	42	22,4	ø28		CLIO4627
DSH-14-20V	59	47	26,45	ø33		CLIO4628

Pour tuyau évacuation condensats isolé CLI04507

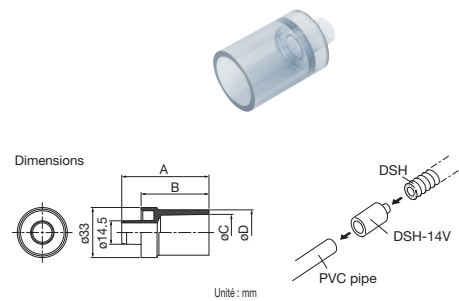

DSH-14C coupleur D14

LIBELLÉS	PCS/PKG	INABA DENKO™ CODE CBM
DSH-14C		CLIO4631

Pour tuyau évacuation condensats isolé CLI04507

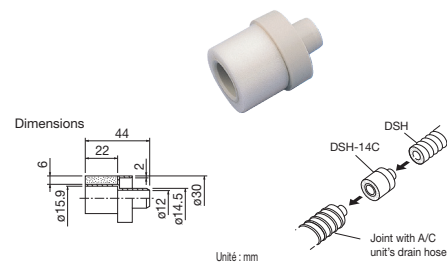

DSH-14J coupleur D14

LIBELLÉS	PCS/PKG	INABA DENKO™ CODE CBM
DSH-14J		CLIO4634

Pour tuyau évacuation condensats isolé CLI04507

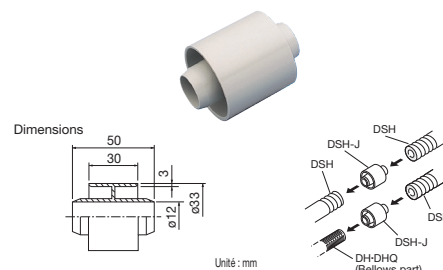

DSH-14H coupleur D14

LIBELLÉS	PCS/PKG	INABA DENKO™ CODE CBM
DSH-14H		CLIO4637

Pour tuyau évacuation condensats isolé CLI04507

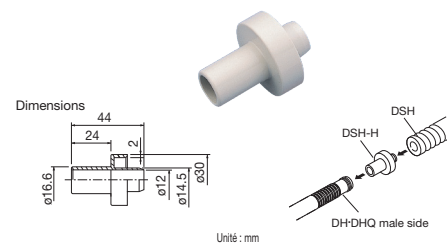

Pompe manuelle aspiration

Déboucher les tuyaux d'évacuation des condensats

Caractéristiques

Possibilité de travailler contre un mur. Débouche efficacement les tuyaux d'évacuation des condensats. Pour des tuyaux de \varnothing 13 à 25 mm. Longueur 25 cm - Diamètre 6 cm - Volume 2 litres.

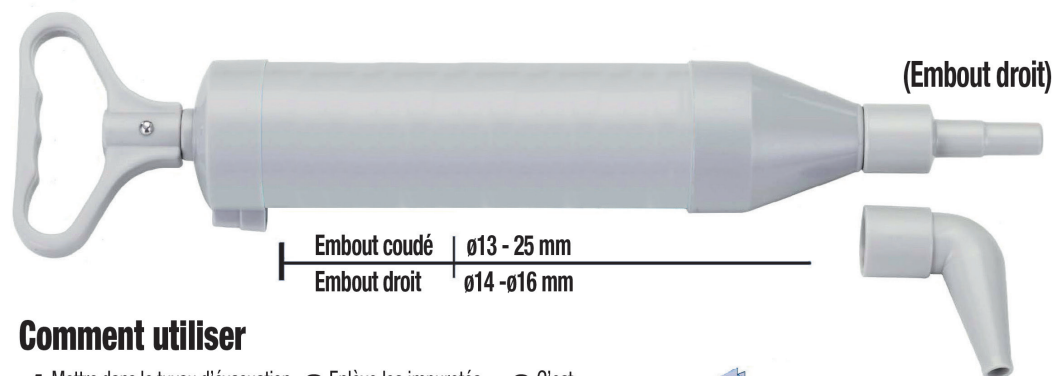

Comment utiliser

1 Mettre dans le tuyau d'évacuation des condensats et pomper 2 ou 3 fois

2 Enlève les impuretés qui bouchent le tuyau

3 C'est débouché !

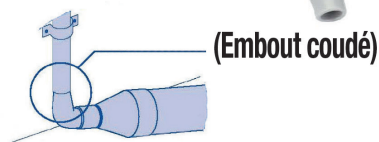
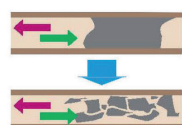

CLIMA CONCEPT

CODE CBM

LIBELLÉS

Pompe manuelle aspiration condensats

CLI04680

Line Shot

Caractéristiques

Permet de déboucher les tuyaux.

RECTORSEAL

CODE CBM

LIBELLÉS

Line shot

CLI04682

Cartouche CO₂

Paquet de 12

CLI04684



Bacs d'évaporation des condensats

Solution permettant l'évaporation des condensats lorsque l'évacuation n'est pas possible.



LIBELLÉS

DÉTAILS

<p>Bac d'évaporation des condensats 236 ml/h Bac de 0,95 litres Résistance 160 W</p>	<ul style="list-style-type: none"> • Réf. : 30-220-05 • Fonctionnement continu 	<p>COP28002</p>	
<p>Bac d'évaporation des condensats 177 ml/h Bac de 1,48 litres Résistance 160 W</p>	<ul style="list-style-type: none"> • Réf. : 31-220 • Fonctionnement continu 	<p>COP28004</p>	
<p>Bac d'évaporation des condensats 207 ml/h Bac de 1,48 litres Résistance 300 W</p>	<ul style="list-style-type: none"> • Réf. : 70-220 • Fonctionnement continu 	<p>COP28006</p>	
<p>Bac d'évaporation des condensats 414 ml/h Bac de 2,2 litres Résistance 320 W</p>	<ul style="list-style-type: none"> • Réf. : 75-220 • Fonctionnement continu 	<p>COP28008</p>	
<p>Bac d'évaporation des condensats 0,9 l/h Bac de 2,4 litres Résistance 800 W</p>	<ul style="list-style-type: none"> • Réf. : CP802-240 • Contact avec flotteur 	<p>COP28010</p>	
<p>Bac d'évaporation des condensats 1,6 l/h Bac de 4,2 litres Résistance 1000 W</p>	<ul style="list-style-type: none"> • Réf. : CP804-240 • Contact avec flotteur 	<p>COP28012</p>	
<p>Bac d'évaporation des condensats 0,95 l/h Bac de 7,1 litres Résistance 1000 W</p>	<ul style="list-style-type: none"> • Réf. : CP804HD-240 • Contact avec flotteur 	<p>COP28014</p>	
<p>Bac d'évaporation des condensats 1,58 l/h Bac de 7,1 litres Résistance 1000 W</p>	<ul style="list-style-type: none"> • Réf. : CP807-240 • Contact avec flotteur 	<p>COP28016</p>	
<p>Bac d'évaporation 1,9 l/h Bac de 14,2 litres Résistance 1000 W</p>	<ul style="list-style-type: none"> • Réf. : CP815-240 • Contact avec flotteur 	<p>COP28018</p>	